

CityLine/CityVu C-Series C200 TimberLine/TimberVu W-Series W200 XO/OX/OXXO Sliding Door Installation Guide

IG-085 REV. 04/24 1.6

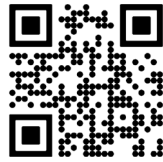

CityLine TimberLine

Scan Here for a Digital Version of the
Installation Guides in English.

Quartz Luxury Windows & Doors:
www.quartzluxurywindows.com



CityVu TimberVu

Scan Here for a Digital Version of the
Installation Guides in English.

Quaker Residential Windows & Doors:
www.quakerresidentialwindows.com

Not Available for Commercial.



Para ver las instrucciones en Espanol, escanea aqui.

If this set of instructions does not match your installation method or the wall conditions of the job site, please check our website listed below for other options, or call Quaker Customer Service for additional information.



Quaker Window Products
504 U.S. Hwy 63 South
Freeburg, MO 65035
(800) 347-0438
www.quakerwindows.com



CityLine/CityVu C-Series C200 TimberLine/TimberVu W-Series W200 XO/OX/OXXO Sliding Door Installation Guide

Read these instructions completely before starting any installation. Failure to install and maintain our product according to these instructions may void any product warranty. These are generic instructions intended to cover most common situations, which may not be appropriate for all installations due to building design, construction materials, or methods used and/or building or site conditions. Please visit our website at www.quakerwindows.com or call 1-800-347-0438 for additional information. Inspect all units for any damage or defects prior to installation.

Tools required by installer:		Materials required by installer:	
Safety Glasses		Utility Knife	
Drill/Driver		Caulk Gun	
Level		Tape Measure	
Hammer		J-Roller	
Putty Knife		Staple Gun	
Phillips #2 Screwdriver - 7" Shank		Hand Clamp	
Metal Chop Saw		#2 Square drive	
		Foam Backer Rod	
		Minimally Expanding Spray Foam	
		Shims (waterproof)	
		C920 Silicone	
		Flashing Tape (Self-Adhering)	
		Water Resistant Barrier/House Wrap (WRB)	
		Fasteners	
		IPA Alcohol	
		Sill Pan	

WARNING

Tools

- Follow manufacturer's instructions for safe operation of tools, and ladders/scaffolding. Always wear safety glasses. Failure to do so could result in injury, product or property damage.

Handling

- Do not store units outside, or in a hot environment. Doing so could result in product damage.
- Do not carry flat.** Doing so could result in product damage, injury, or property damage.
- Stack units as straight as possible to avoid bowing. **Do not lay flat!**

Glass

- If broken, glass can fragment causing injury. All Quaker products are available with safety glass. In many areas, local building codes require safety glass in certain locations and/or applications. Quaker door products are provided with safety glass per industry standards. Consult your local building codes for more definitive information.

Fastening

- Metal fasteners and components could corrode when used with preservative-treated lumber. Use approved fasteners and components to fasten window or door. Failure to do so could cause a failure resulting in injury, product or property damage.
- Fastener must attach to a structural framing member with 1 1/2" minimum fastener embedment, or minimum 3 full threads with a minimum 5/16" head as products were tested with.
- Quaker does not supply anchorage/fastener calculations, and is not responsible for determining structural adequacy of the anchorage and fasteners used to install our products, or the openings into which they are installed.**
- Do not over drive screws or nails.** Doing so could result in product damage.

Notice

- The suggested overhang of the structure should match the height of the unit being installed.

⚠ CAUTION**Installation**

- Maintain a minimum of 1/4" between the window or door frame and exterior finish materials. Failure to do so could result in product or property damage.
- Nailing flanges and drip caps (integral or applied) **do not** take the place of window and door flashing. All windows and doors must be properly flashed and sealed with material compatible sealant for protection against water and air infiltration around the entire perimeter. Failure to do so could result in product or property damage.
- Place shims around perimeter as required. Door must be properly shimmed. Failure to do so could affect operation and product performance and could result in product damage.
- Live or dead loads transferred into our product can affect functionality, damage frame joinery or cause glass failures. Dead loads such as upper levels, roof, etc. Should be constructed before window or door is installed.
- Loads shall be designed to withstand the most critical effects of load factors and load combinations as required by the building code. (Loads are including but not limited to Live, Dead, Collateral, Auxiliary, Thermally induced, Seismic, etc.)
- Maximum vertical deflection of the header under all Load combination should not exceed 1/8".
- **Do not** drill through or into door sill to install alarm wires.

Sealing

- Follow instructions of foam, sealant, and flashing manufacturers regarding safety, material application, compatibility, and periodic maintenance for continued weather resistance of their products. Failure to do so could result in product or property damage. **DO NOT** overfill between the frame and opening.
- Minimally expanding foam insulation must be compliant with AAMA 812-19.
- Quaker requires 100% silicone (ASTM C920 compliant) neutral cure only sealant. Always clean all areas where sealant will be applied. Failure to do so could result in product or property damage.
- Flashing tape must meet ASTM-D779 performance requirements.

Joining

- Do not join any window or door to any window or door not designed for joining. Joined windows and doors must be individually supported in the opening. Failure to do so could affect operation and product performance and could result in product or property damage.

Cleaning

- Acid solutions used for cleaning will damage glass, fasteners, hardware, and metal flashing. Protect these products and follow cleaning products manufacturers instructions. If acid contacts the window or door, wash all surfaces immediately with clean water.
- **Do not** use razor blades to clean glass surface. Glass damage could result.
- Clean glass using liquid glass cleaner.
- Clean frame, sash, panels, and insect screens using mild detergent and warm water with a soft cloth or brush.

IMPORTANT

- Buildings constructed prior to 1978 could contain lead paint which could be disturbed during window or door replacement. For more information on proper management of lead paint, go to: www.epa.gov/lead
- Care must be taken to properly recycle or dispose of old materials. Any recyclable materials should be separated from non-recyclable or hazardous materials. Please consult with local or state authorities regarding proper disposal of non-recyclable or hazardous materials

⚠ WARNING: This product can expose you to chemicals including titanium dioxide or methanol, which are known to the State of California to cause cancer and birth defects or other reproductive harm. For more information go to www.P65Warnings.ca.gov.

⚠ WARNING: Drilling, sawing, sanding or machining wood products can expose you to wood dust, a substance known to the State of California to cause cancer. Avoid inhaling wood dust or use a dust mask or other safeguards for personal protection. For more information go to www.P65Warnings.ca.gov/wood.

1

Verify Header Support

Ensure the roof over the door system is full supported. Take into account the weight of any materials around the door system, because this may cause deflection. No more than 1/8" deflection is allowed for install. Confirm that all materials and fasteners are adequate for the load requirements.

If you have any questions please feel free to call us at Quaker Windows.

Phone : 1 (800) 347 – 0438.

2

QUAKER WINDOWS & DOORS					STANDARD OPERATING PROCEDURE		
TITLE				DATE	ASSOCIATE		
Packing List C200 Bi-parting Sliding Door				5/22/2023	Jloehner		
SOP#	CA#00	VERSION	1.0	DEPT	352	SERIES	C200 Packing List
<input type="checkbox"/>	FE_21_7X10.35_DT--	(Corner Keys)					4
<input type="checkbox"/>	FE FAST2--	(Corner Key Fastener)					16
<input type="checkbox"/>	M25385 --	Head/Jamb Closure --For Aluminum Only					3
<input type="checkbox"/>	M25385 --	Head/Jamb Closure --For Wood Only					3
<input type="checkbox"/>	BRS-9086--	(Jamb Filler Cover)					2
<small>*Watch for WD-EX behind Central Plastic Cover pieces this is for Wood Veneer Applied Pieces.</small>							
<input type="checkbox"/>	BRS-9052-	(Frame Parting Strip Cover)					2
<input type="checkbox"/>	QWP-CG10-BLK/WHT-	(Head Corner Frame Gasket)					2
<input type="checkbox"/>	QWP-CG11-BLK/WHT -	(Frame Sill to Jamb Gasket)					2

Before installing your door, unpack all parts and place near the opening. Make sure you have all parts according to the packing slip and check for damaged parts.

3

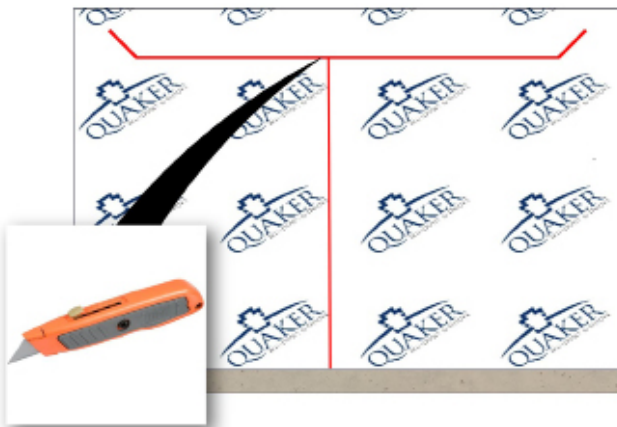

Apply the house wrap according to the manufacturer's instructions and cut T-pattern opening as shown above. Cut top flap angles at 45 degrees and 1" longer than the width of flashing tape being used.

4

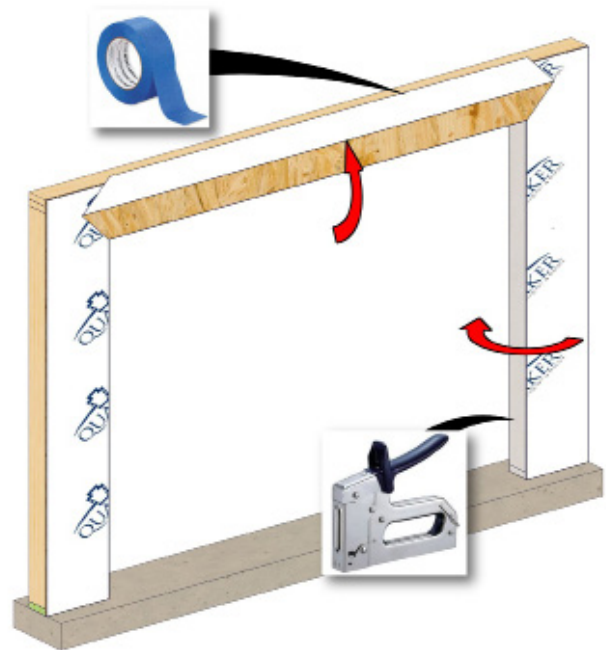

Fold the house wrap around the jambs to the interior and staple it to the interior framing. Fold the house wrap flap up and temporarily tape it in place.

5

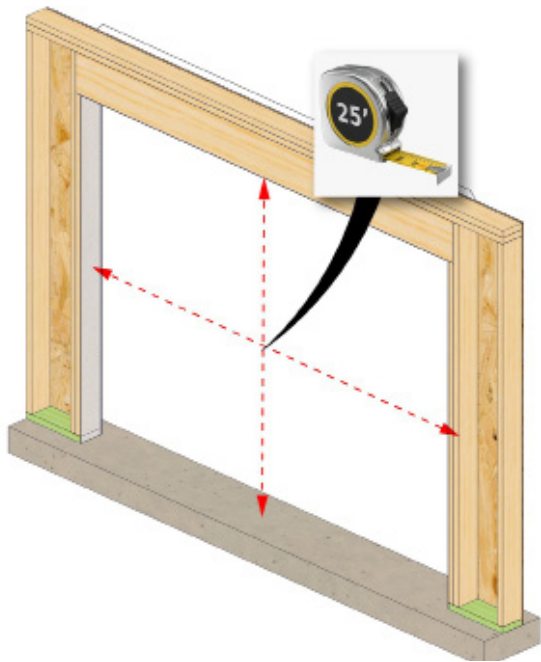

Measure and verify the rough opening is sized correctly. The rough opening should be $\frac{3}{4}$ " wider and $\frac{1}{2}$ " taller than the unit. Allow additional space for flashing thickness, installation clips, joining components, and their fasteners.

6

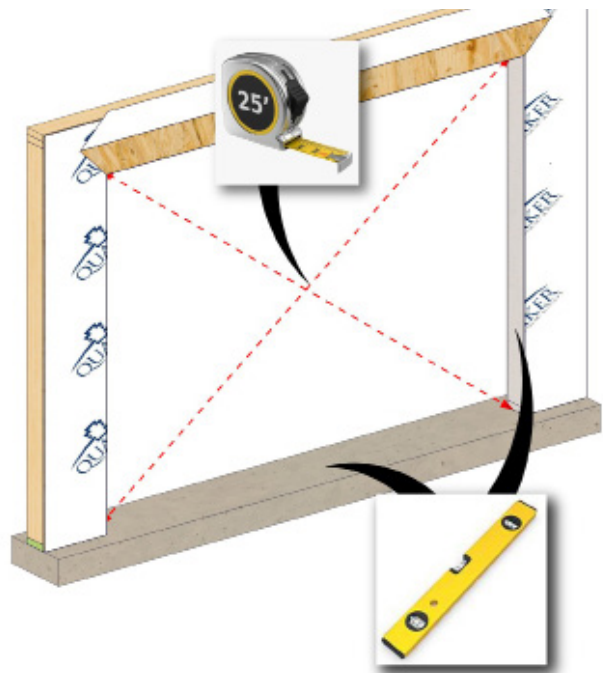

Check that the opening is square. The diagonal measurements need to be within $\frac{1}{8}$ " of each other. Verify the rough opening is plumb and level.



The sill plate beneath the unit must be level for proper unit operation.

7

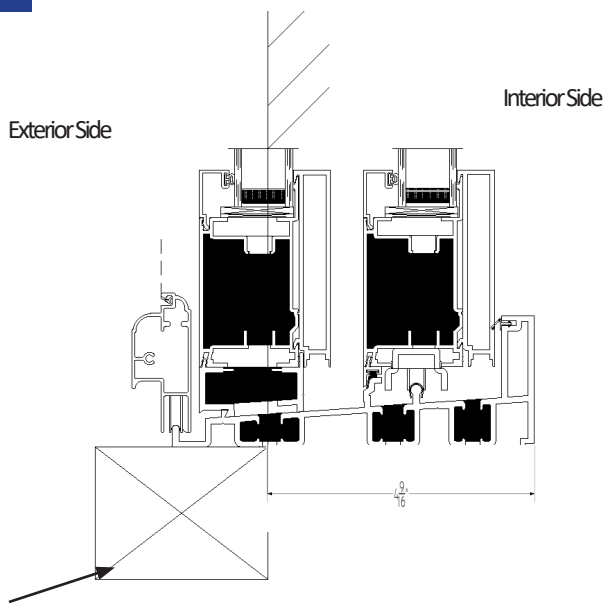

Sill Support by Others

The frame sill will set $4 \frac{9}{16}$ " in from the exterior face of wall framing, where the frame positioning fin sits.



The unit must be supported the full width and depth of the sill.

(Note: For Nail fin installation only.)

8

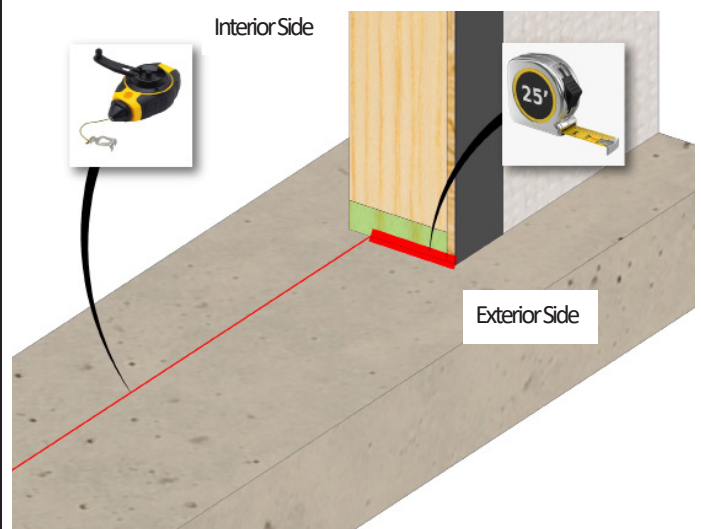

Measure and set a chalk line on the sub floor $4 \frac{9}{16}$ " in from the exterior wall face. Dry fit the door frame sill system with the rear upturned leg on this line.

9

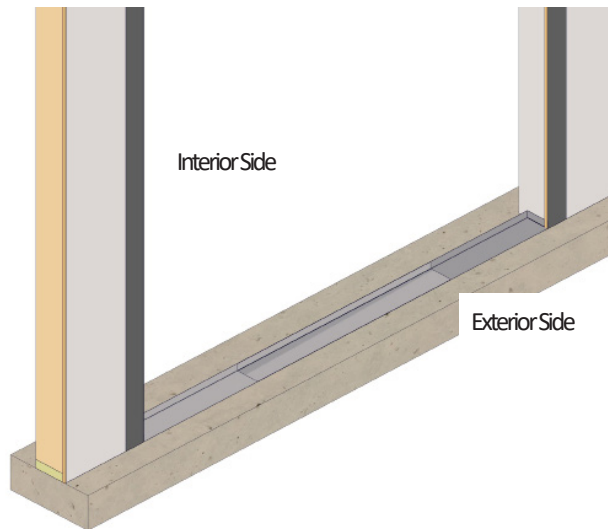

The installer will have to supply their OWN sill pans that meets all AAMA installation requirements.

10

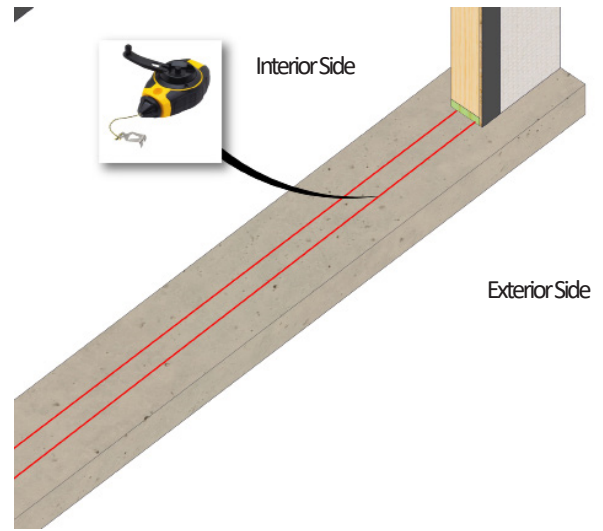

Snap another chalk line, the width of sill pan from previous chalk line. This is where the sill pan will sit and where silicone will be applied.

11

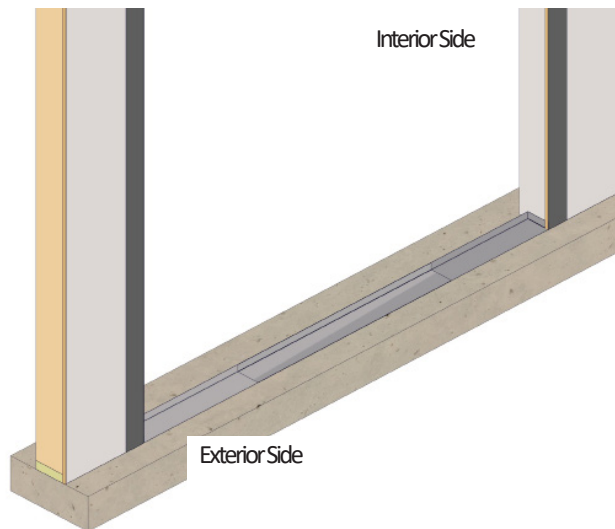

Rough fit the sill pan in place to ensure of proper fitment.

SILL MUST BE LEVEL! Quaker first recommends self leveling concrete, if not available shim 1' or less, on center.

FRAME ASSEMBLY

Assemble the frame to make sure sizing is correct.

LAY FRAME DOWN ON A PROTECTED SURFACE!

12

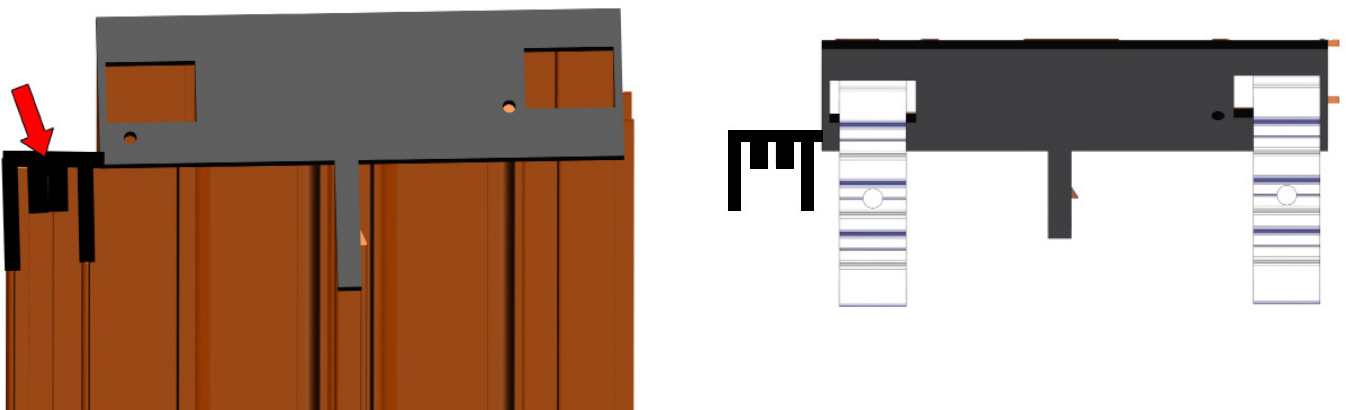

Clean surfaces with IPA Alcohol then place a head corner frame gasket (Part #: QWP-CG10-BLK(B/W)) on each face profile of the frame header, take color matching silicone and trace the screen track. Place 2 of the corner keys (Part #: FE_25-7x10-35-DT) in both ends of the frame header and join to both frame jambs. Trim weather strip flush to both ends.

13

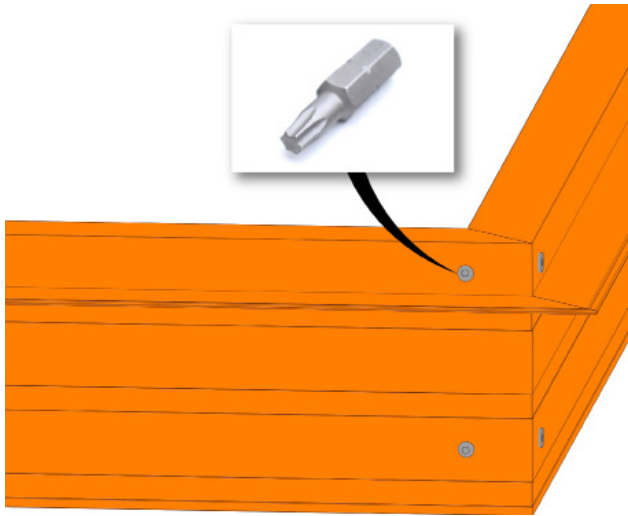

With a T-20 bit, start corner key fastener (Part #: FE FAST2) into the keys at each corner. Then tighten.

14

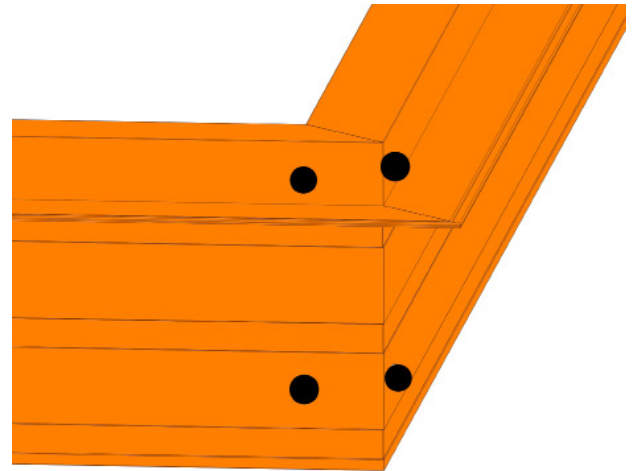

Cover fasteners with silicone.

15



Clean surfaces with IPA Alcohol then place a frame sill to jamb gasket (Part #: QWP-CG11-(BLK/WHT)) and apply to the bottom, square cut end of frame.

16

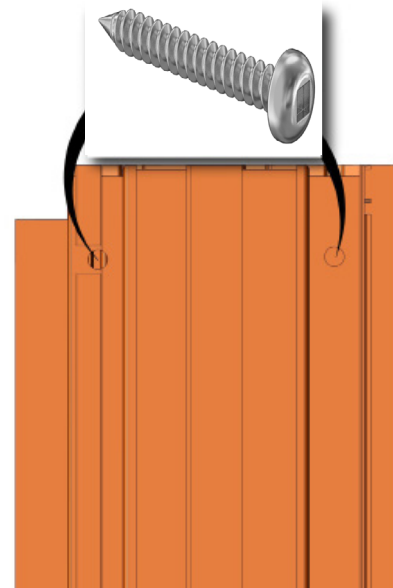

Line up the jamb fasteners holes in the sill, with the screw bosses of the frame and install square drive fasteners (Part #: MSP10AX1-SUB).



BE VERY CARE NOT TO BREAK SCREWS OFF!!
Set impact to the lowest setting.

17

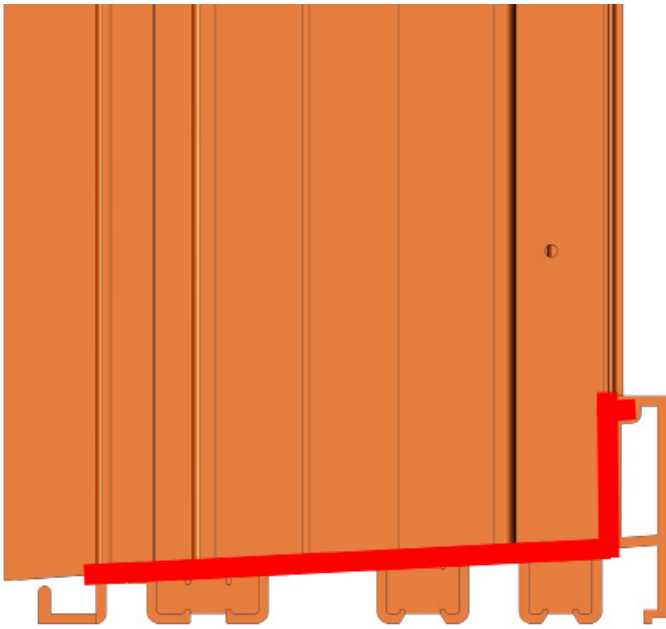

Apply silicone to seal the back of the frame and sill connection, then tool in.

18

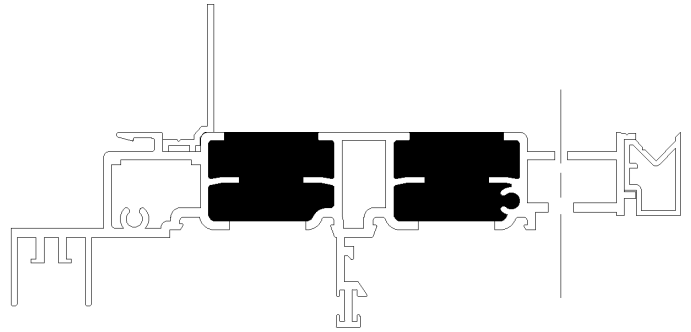

First drill a hole (11/32") through the frame, as shown above. Then take a 3/8" drill bit and drill through the first web making a clearance hole for the fasteners head clear. Install fasteners (Part #: MF#10-12X21/2).

NOTE: Please follow this step ONLY if factory pre-drilled holes are not available.

19

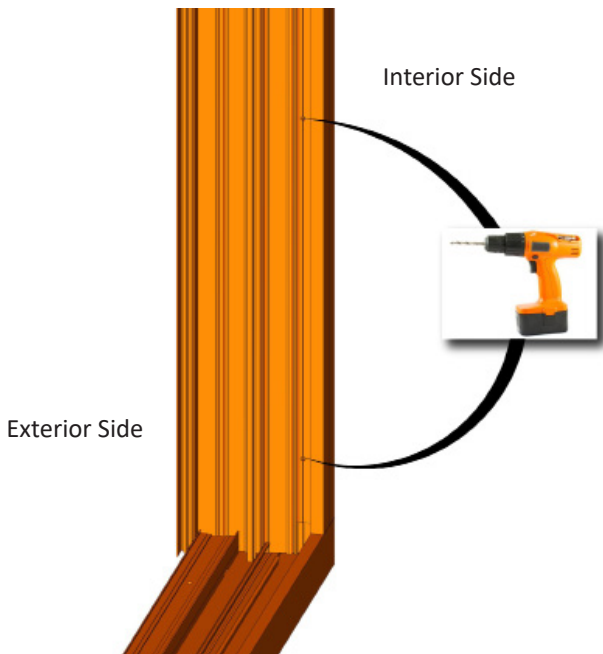

Drill holes through the frame of the header & jambs, typically 6" from ends and 24" on center. (Drill bit size is based off the fasteners size being used.)

20

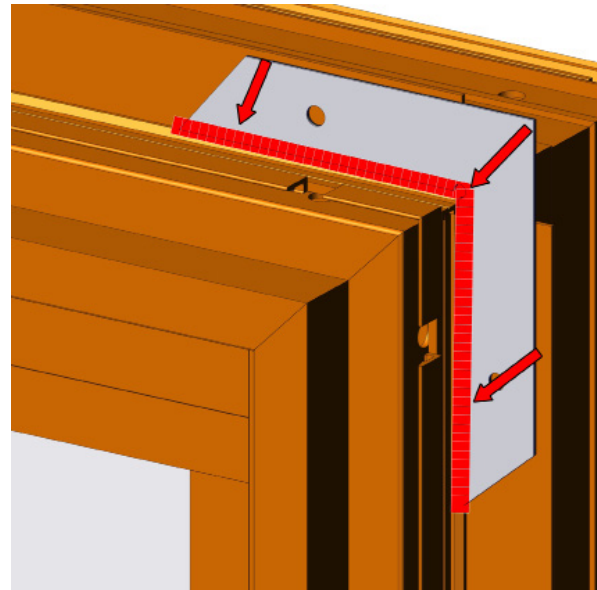

Remove backing off of the nail fin corner and attach the nail fin corner to the nail fins. Then silicone along the frame as shown above.

SILL PAN INSTALL

The installer will have to supply their OWN sill pans that meets all AAMA installation requirements.

21

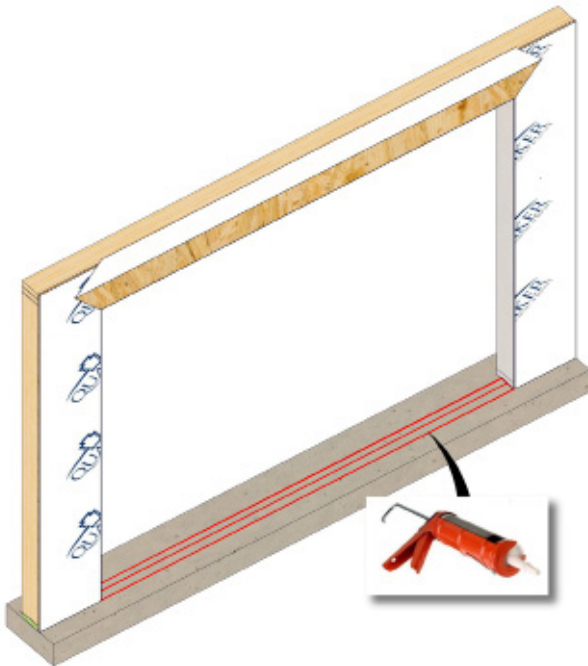

Apply three 3/8" continuous beads of sealant across the entire width of the rough opening sill where the sill pan will set. Apply two 3/8" continuous beads the width of the pan, 1/2" from each side of opening as shown above.

22

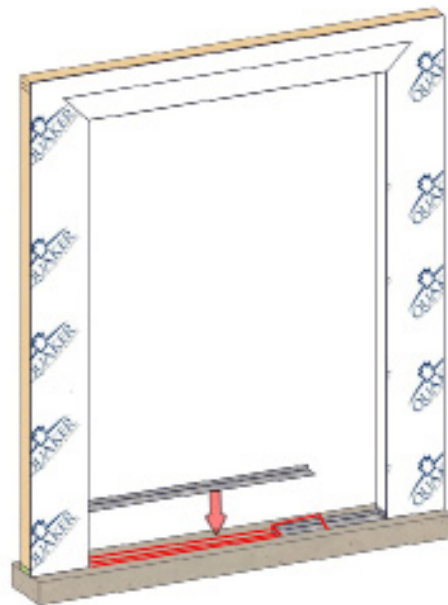

Install sill pan on top of silicone.

NOTE:

If multiple sill pans are required, silicone joint and tool in.

FRAME INSTALL

23

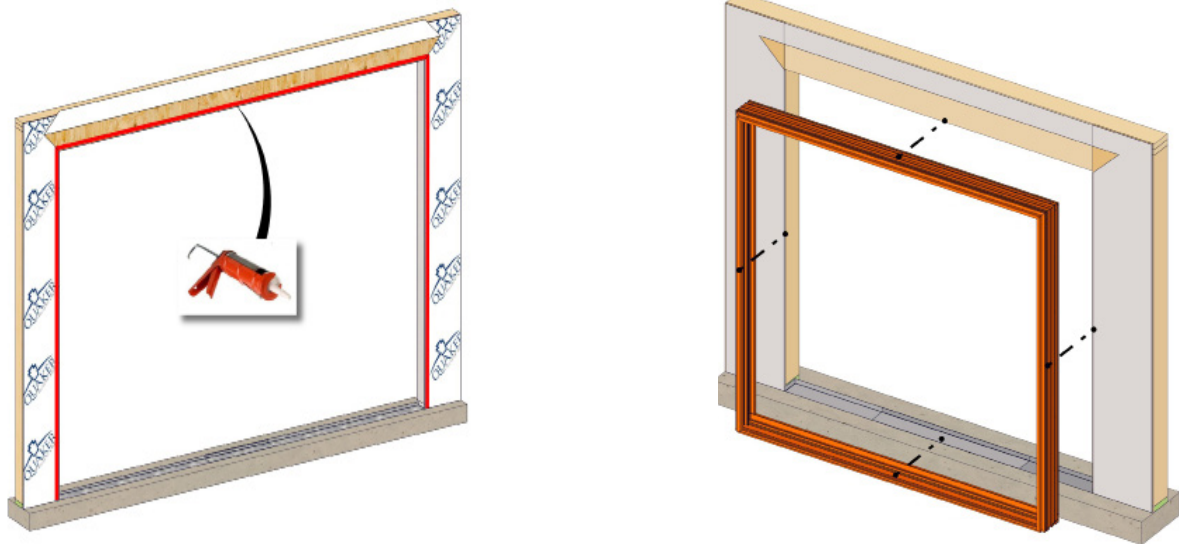
**FOR NAIL FIN INSTALL ONLY!**

(A) Apply a continuous 3/8" bead of sealant around the exterior perimeter of the opening as shown and along sill pan. Install the frame by sliding in the rough opening with the fin to the exterior side. Set frame onto the sill pan.

24

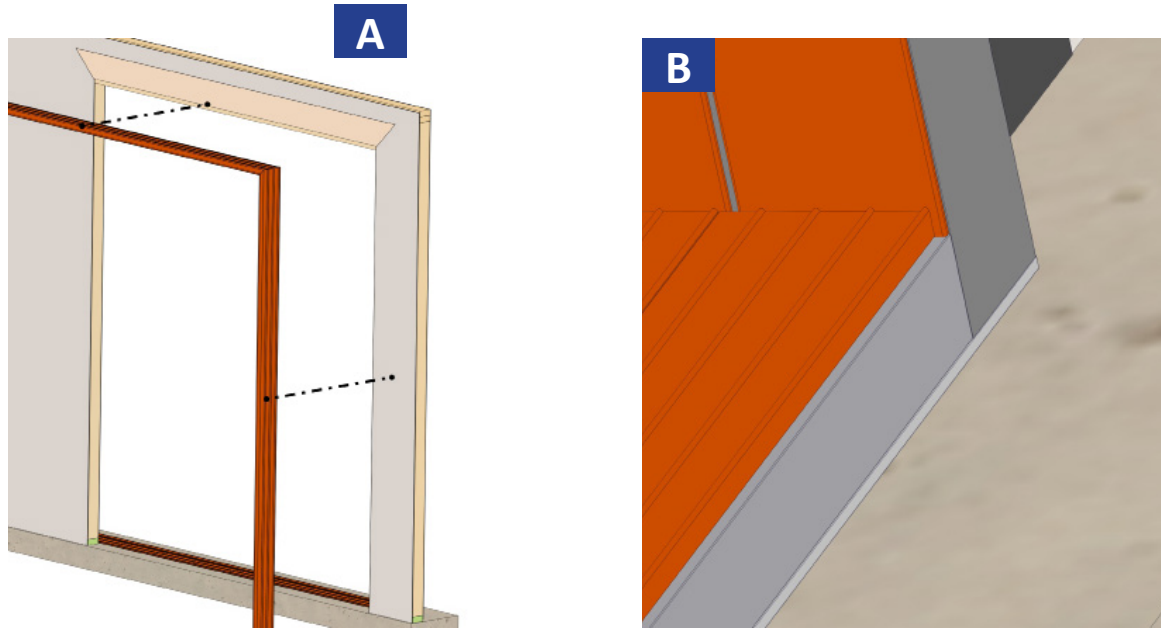
**FOR NO NAIL FIN INSTALL ONLY!**

- (A) From the exterior, install the frame by sliding in the rough opening.
 (B) Set frame onto the sill pan.

25

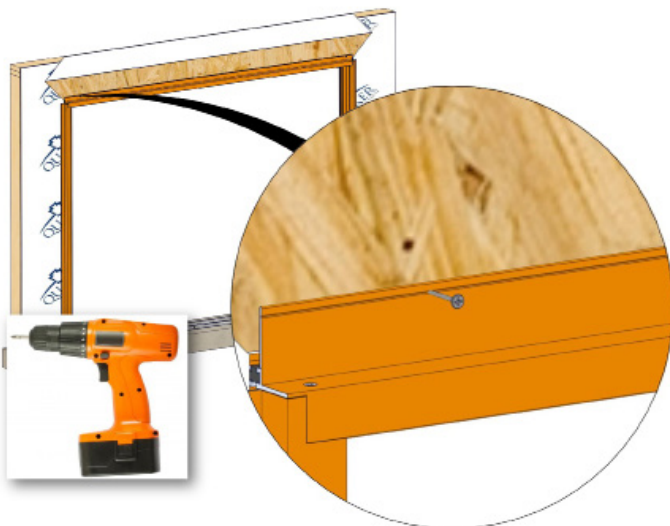
**NAIL FIN ONLY!**

Temporarily secure the frame in the opening at the head corner(s) by tacking a fastener through a slotted hole in the nail fin.

26

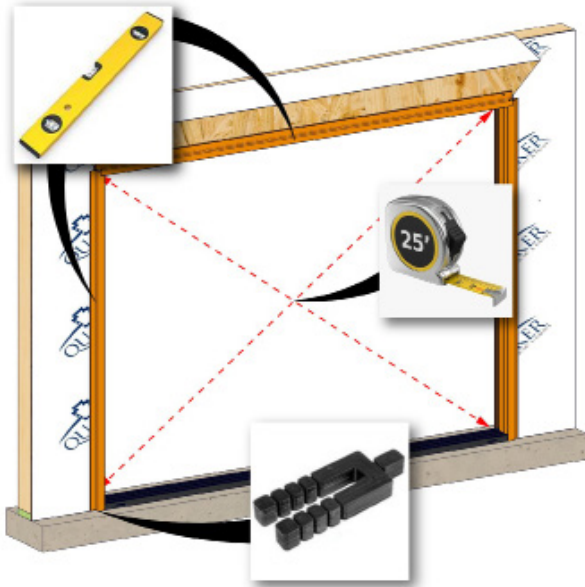

Square, level, and plumb the frame. Adjust shims as needed until diagonal measurements are within 1/8". Shim behind the header and jambs as necessary.

27

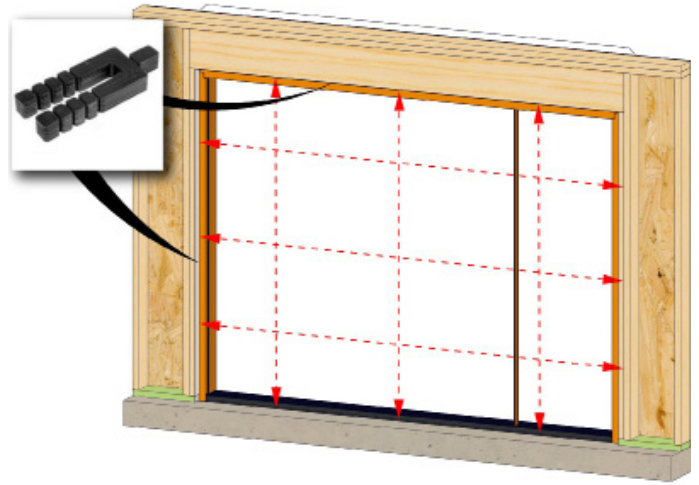

Check that the door frame is not bowed at jambs or head, a string line may be required. Adjust shims as needed but verify measurements are within 1/16".

28

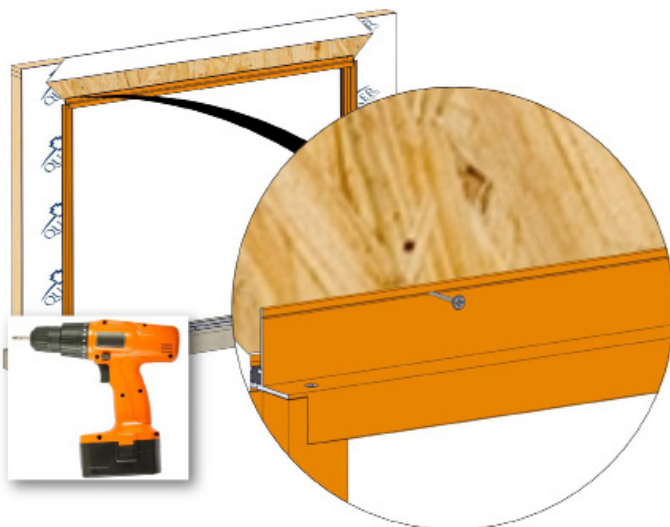
**NAIL FIN ONLY!**

Fully tighten the fasteners down now to hold the frame in place. All fastener locations are to shimmed between framing and condition

29

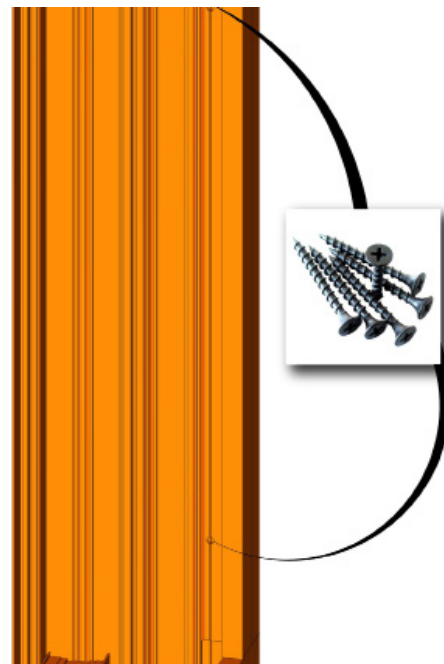

Fully fasten the screws down now to hold the frame in place. The holes through the interior track of the header & jambs, typically 6" from ends and 24" on center for fasteners. All fastener locations are to shimmed between framing and condition.

PANEL INSTALL

Two and Four panels will be installed exactly the same way. The fixed panels will be installed first and then the active panels.

30

Glazing Beads to Exterior



From the exterior, install the fixed panel with the setting chair, by tilting the top into the exterior most head track. Set the bottom of the fixed chair against the lip of the sill.
 *Note orientation of interlock rails when choosing panels.
 *Note glazing beads are to the exterior side.

31



Slide the fixed panel into the frame jamb. Pull towards the exterior this will help in the next steps.

32

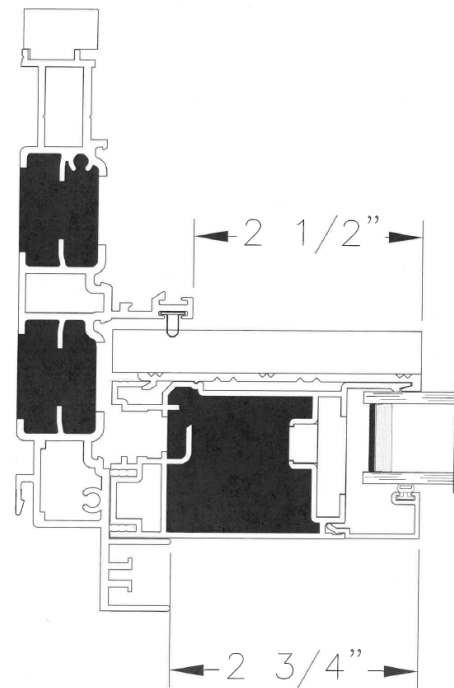

See above diagram. Be sure the fixed panel is seated fully into the frame jamb.

33

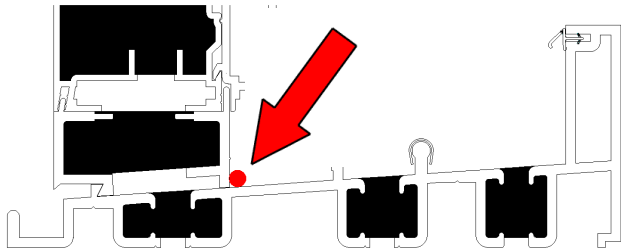

Run a bead of sealant along the base of the setting chair on the interior side.

NOTE: DO NOT COVER THE WEEPS, ROUGHLY 3" from each end.

34

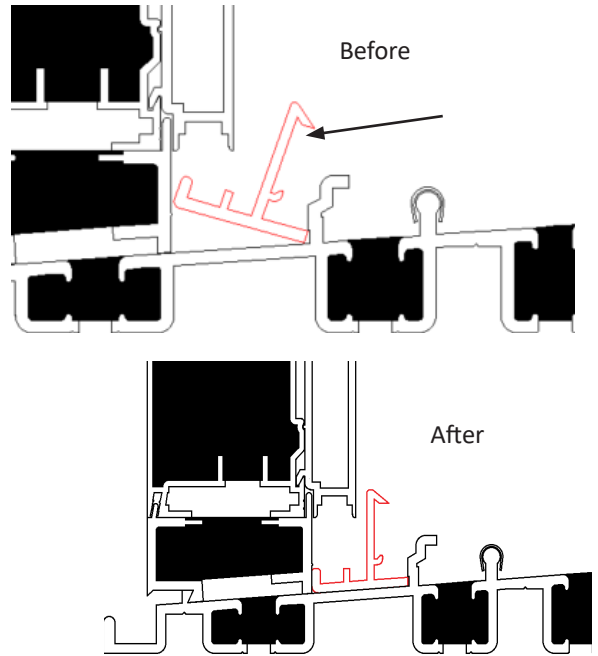

Lock the panel sill in place with three sill compression locks (Part #: M25381-PCS). Set fixed panel sill compression lock down in the track and then take a flat head screw driver and pop into place as shown above.

One on each side of the panel and one in the middle.

DO NOT COVER THE WEEP SLOTS.

35

Interior Side

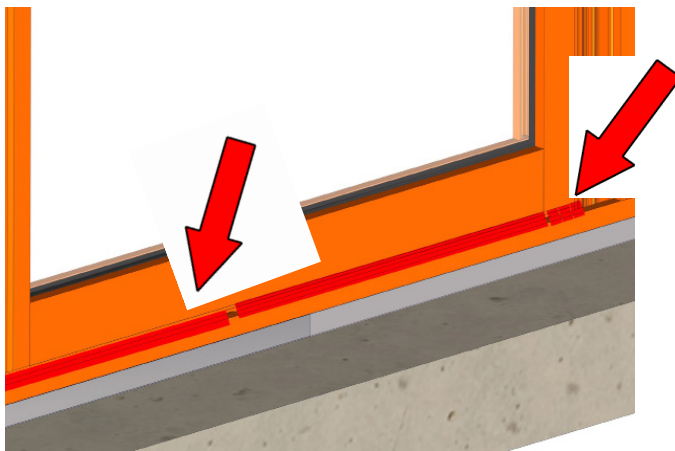

Take baffle (Part #: QWP-50x75X60), cut to length, then press the baffle down between compression locks and the frame. The baffle will run full length.

36

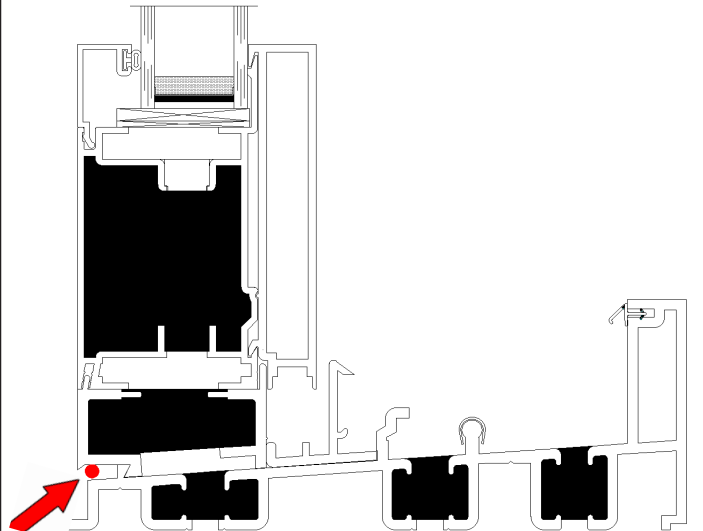

On the exterior side, run a continuous bead of sealant along the bottom of the setting chair, **(DO NOT COVER THE WEEPS).**

37

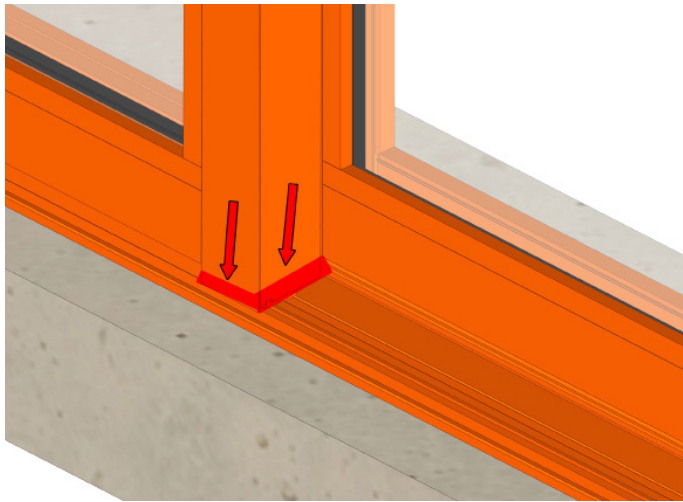

Silicone along the bottom of the exterior of the interlock.

38

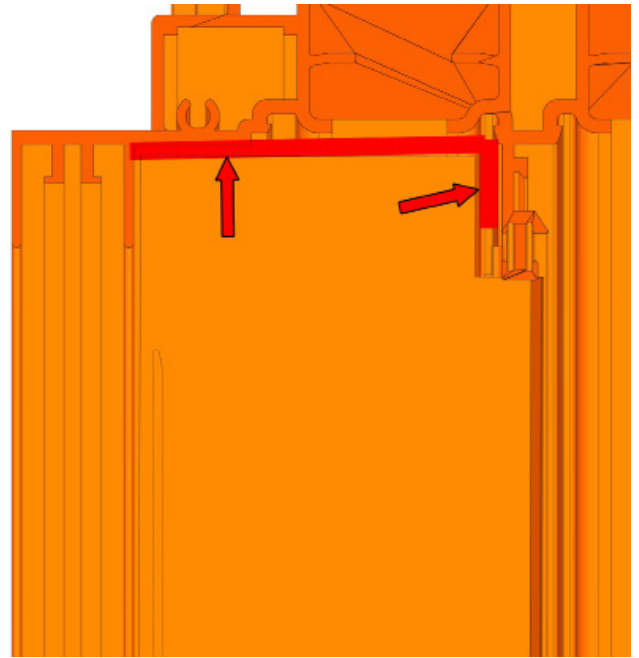

Press fixed panel weep baffle (Part #: QWP-50x75X60) in above the top of the fixed panel between the panel and frame. Then silicone and tool in smoothly with a putty knife.

39

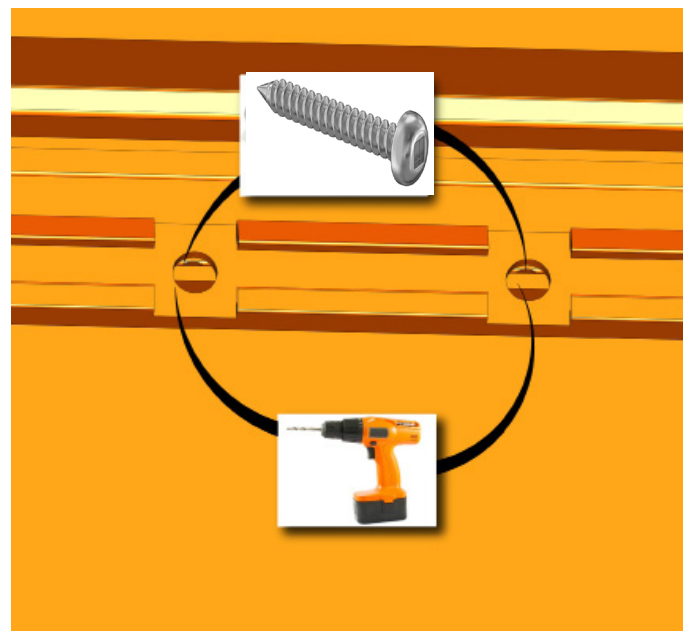

To secure the fixed panel, drill a 11/64" hole into the panel along the frame where the holes are already pre drilled. Holes will be along the frame jamb, and there will also be 2 in the frame head. Verify that the panel meeting rail is plumb in the opening.

40

Frame Jamb

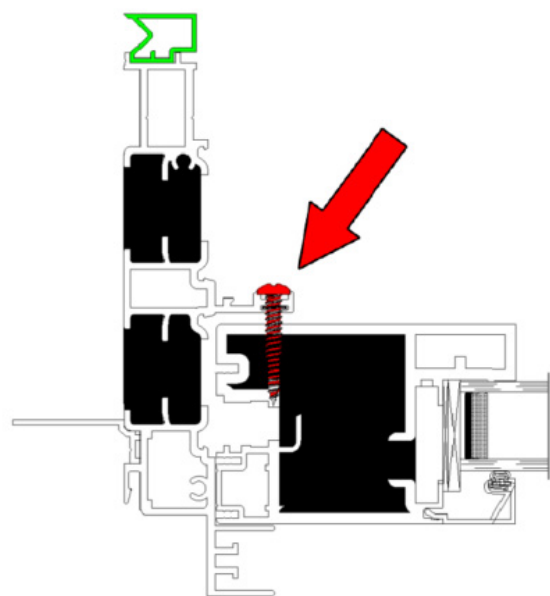

Install a #10 x 1 1/4" jamb and head parting strip fastener (Part #: 171901) at every hole from the previous step on the panel.

41

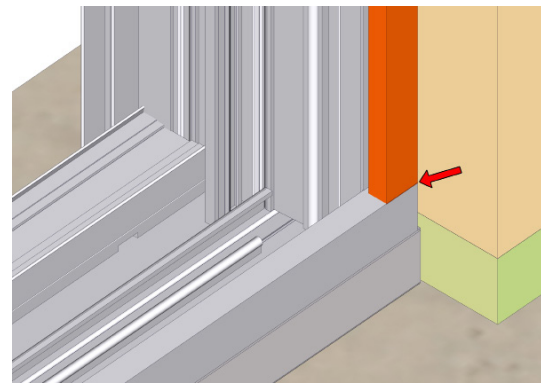
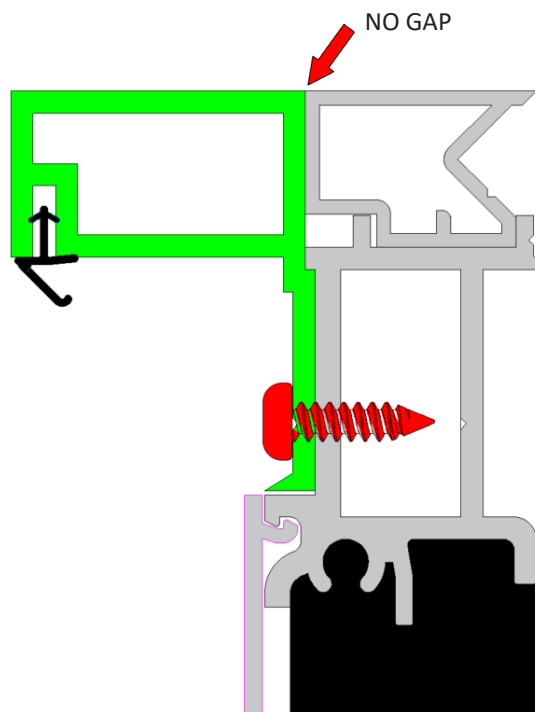

Closure and sill should be flush.

Repeat Step 30 - 41 for 4 panel Doors.

Install right and left jamb closures (Part #: M25386 ALUM or M25385 Wood), by cutting to length and match drill 11/64" holes into the frame. Install fasteners (Part #: MPS10X1/2) in the right and left closures into the frame.

NOTE: BE SURE TO PULL CLOSURE TO YOU AND PRESS INTO THE FRAME JAMB, MAKE AS FLUSH AS POSSIBLE.

42

Active Panel

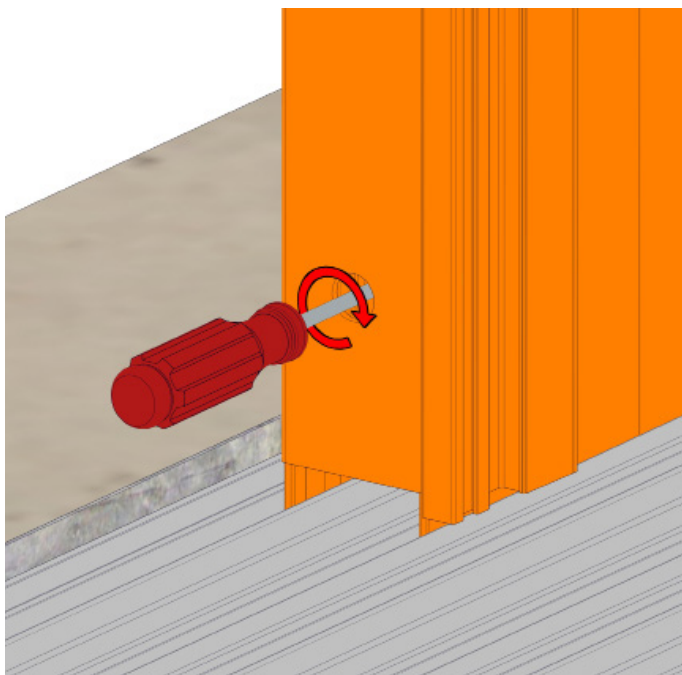

Use a #2 phillips screwdriver to engage the roller adjustment, on both sides of a panel. Adjust the rollers about half way up, this will help you align the roller on the track properly.

43

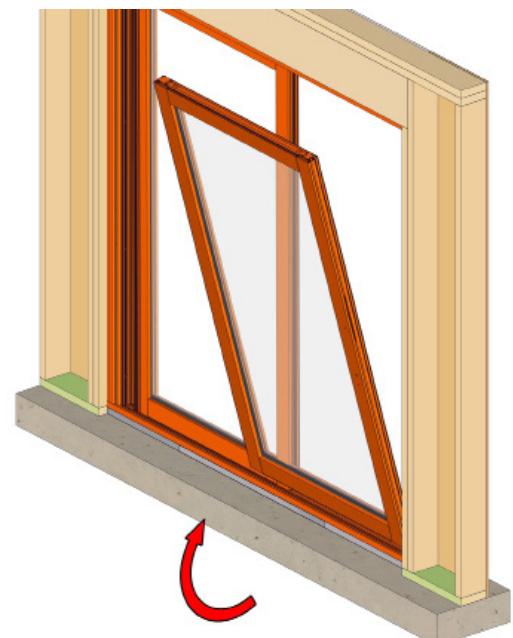

On the interior side set the active panel on the roller track. Make sure the panels are overlapped when installing so the interlocks will engage properly. Slide panel to the fixed jamb. Make sure the closure captures active panel and operates properly.

44

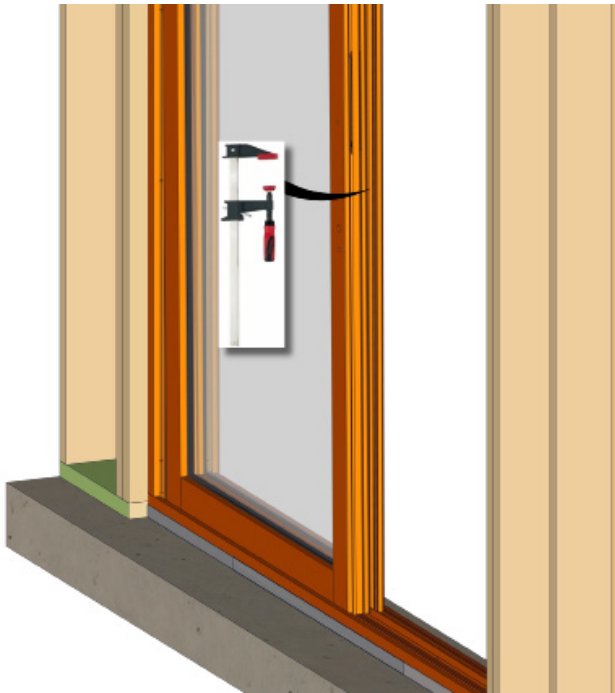

After the rollers are adjusted, open the door, and place a clamp on the active jamb to the fixed jamb holding the active panel in place so it cannot fall out.

NOTE: Be careful not to scratch the panels.

45

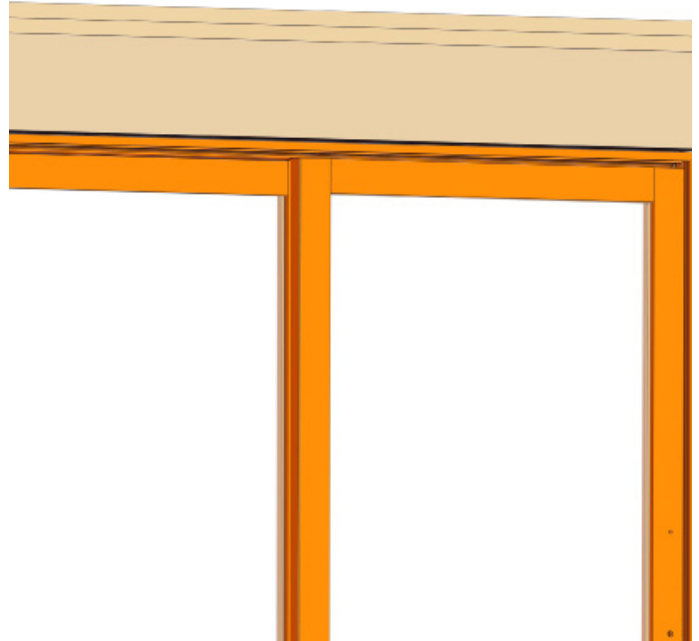

Take the head closure, trim to fit between the jamb closures, and slide it over the head of the panel.

46

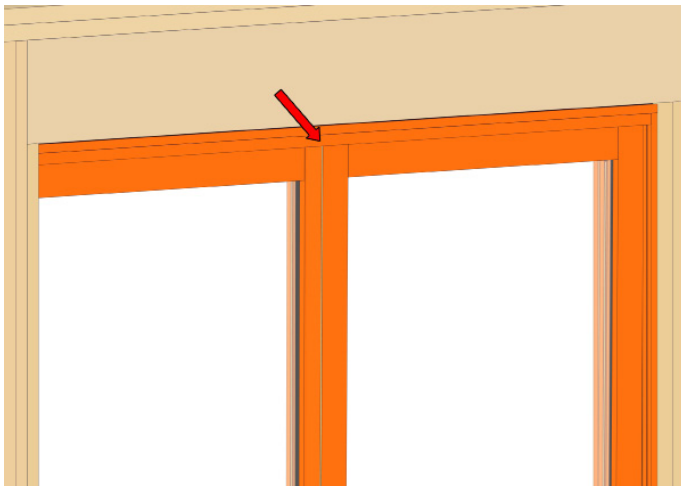

Drill a 11/64" diameter hole and match drill in head closure into frame to support the head closure.

47

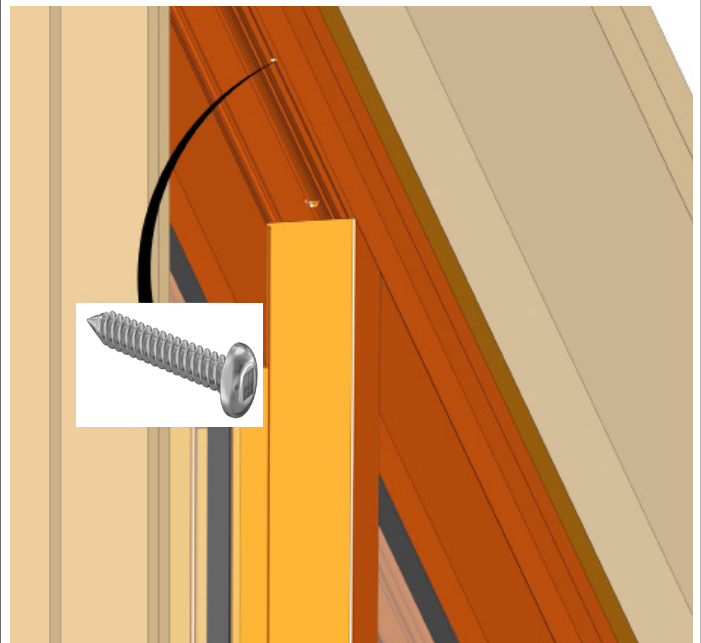

Install the interior closure fasteners (Part #: MPS10X1/2) in the head closure, into the frame, to lock the panel in place.

Trim head closure if necessary.

48

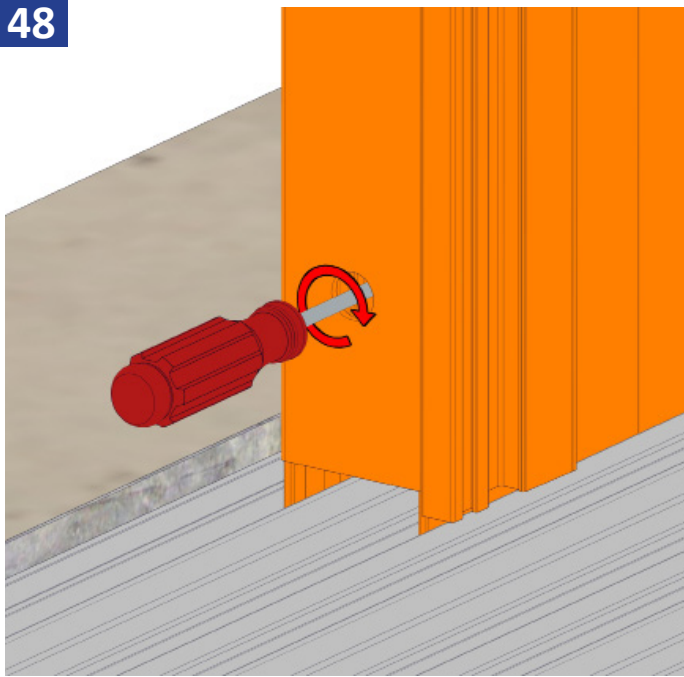

Use a #2 phillips screwdriver to engage the roller adjustment on both sides of a panel. Turn clockwise to raise the panel and provide smooth rolling. If possible, lift the panels slightly when adjusting to take pressure off the rollers. Roll panel back and forth 2-3 times to verify roller height is set. Repeat this step for each panel installed.

49

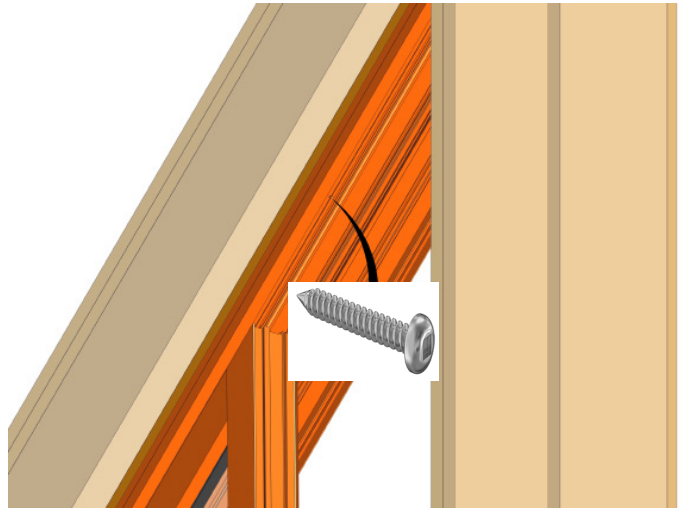

Slide the panel over to finish drilling and installing fasteners in the head closure.

50

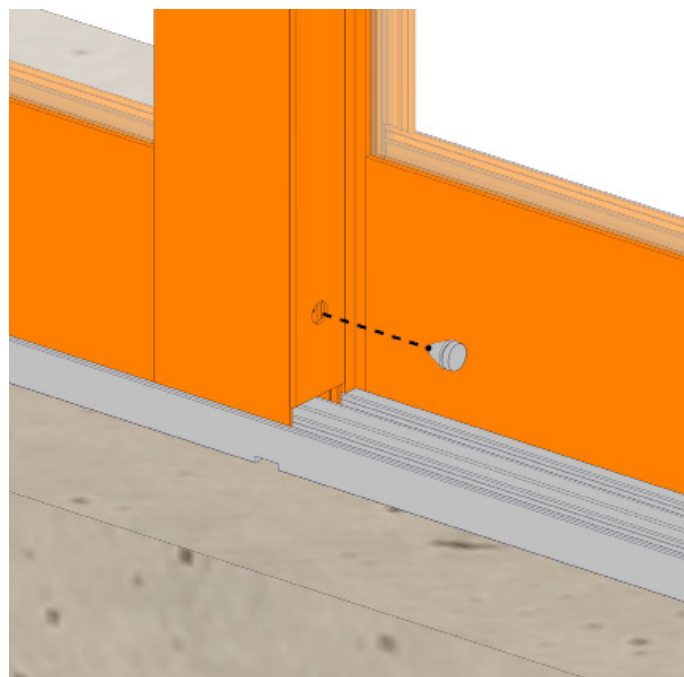

Once all panels have been adjusted install the panel bumpers into each roller adjustment hole.

Repeat steps 42-49 for the other panel for a four panel door system.

51

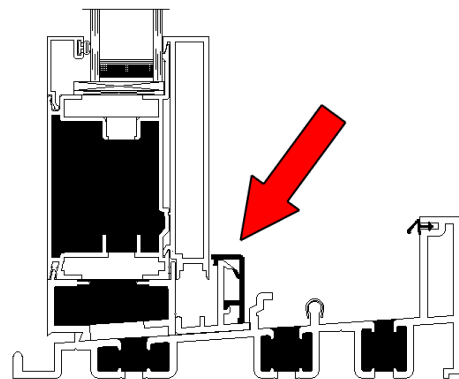

Measure from the interlock of the fixed panel to the front of the frame jamb and cut to length. Then snap the vinyl frame parting (Part #: BRS-9052) with a rubber mallet. Strip cover in the sill along the fixed panel that runs from frame jamb to panel meeting rail.

52

Active

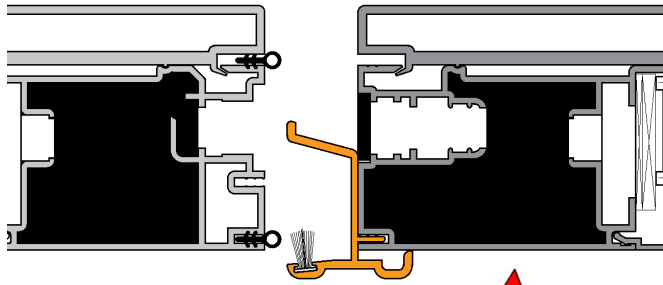

Inactive

**Bi-Parting Doors Only**

This is how the active and inactive rails should meet.

Frame Cover

53



Trim to fit and notch accordingly. Snap in the interior frame jamb filler cover (Part #: BRS-9086) in the inactive frame jamb.

NOTE: For ease of installation, install the interior side of the cover first and then snap the exterior side in place. 4

54

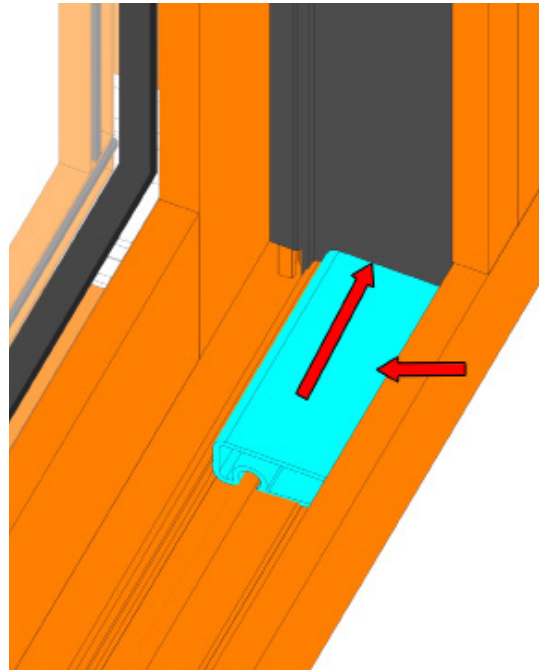

Press the 4" rubber bumper stop onto the sill and slide over to the frame.

Weather Proofing

55

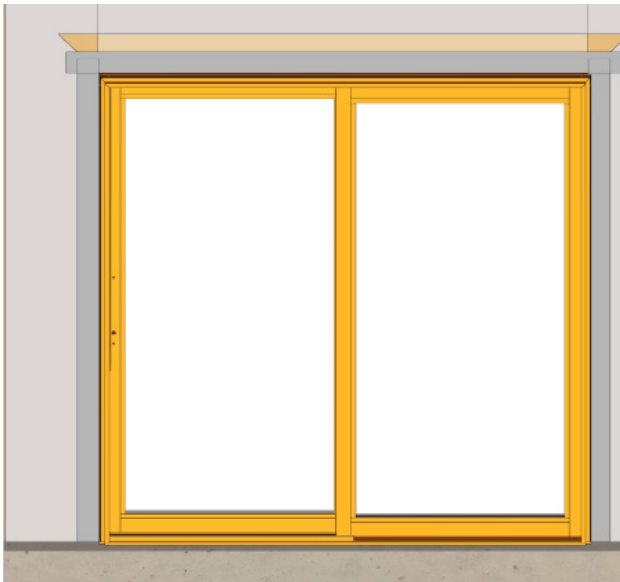

Apply flashing tape at the sides of the door as shown. Smooth using a J-roller. Extend tape a minimum of 2" past door frame, but not more than the thickness of the flashing tape.

56

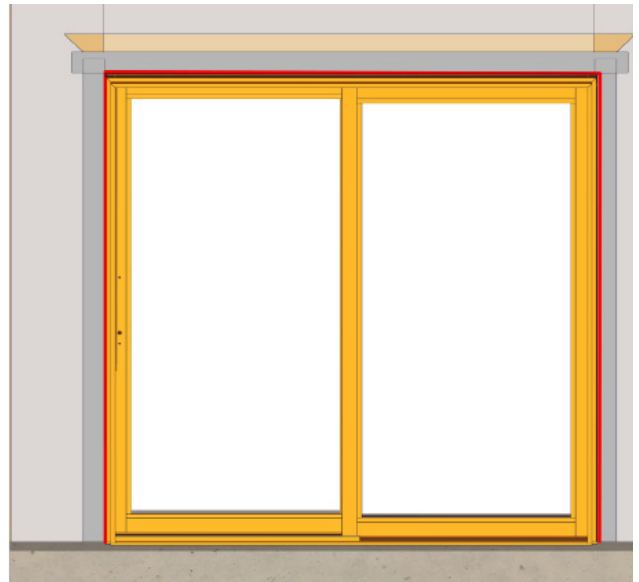

Apply a 3/8" sealant bead to the top exterior edge of door frame before installing the drip cap. Apply flashing tape over the drip cap leg, overlapping the side flashing as shown. Smooth using a J-roller.



Side flashing cannot extend above the top flashing. Doing so could result in product or property damage.

57

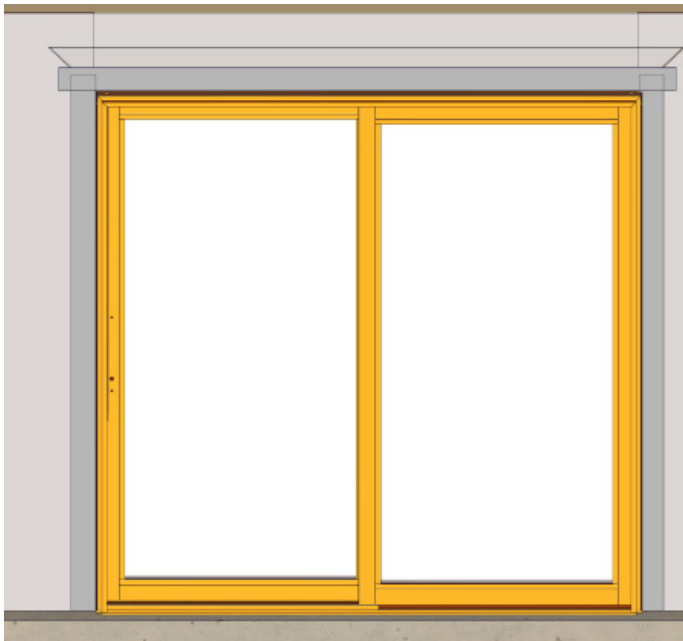

Unfold the house wrap top flap and tape the angled seams as shown.

58



Insulate the gap between the door and framing with minimally expanding spray foam, and seal the entire interior perimeter with sealant.

59

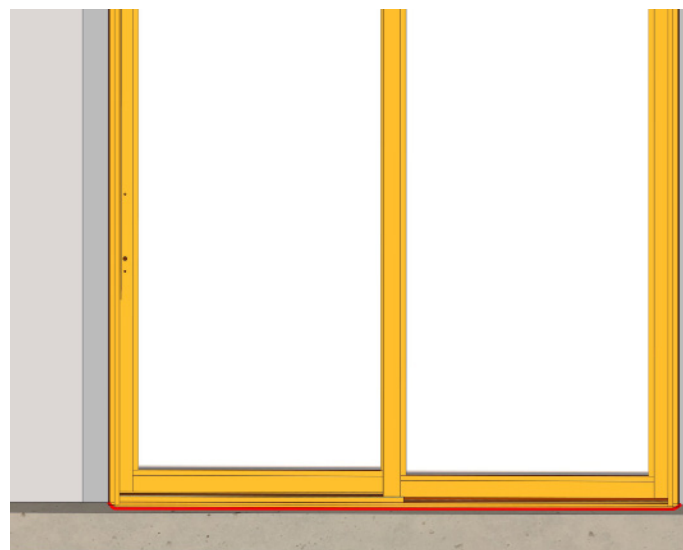

Apply a continuous bead of sealant at the exterior base of the sill. Be sure to not block the weeps on the bottom of the sill.

60

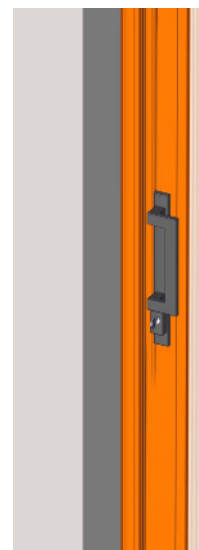

Install the handle per the instruction that is in the box of the handle. Also adjust the handle to lock properly.